

## Maintenance

PUQ PRESS®

**Coffee gets everywhere.** One day a week, spend 5 minutes cleaning to prevent Puq from gaining weight it doesn't need.

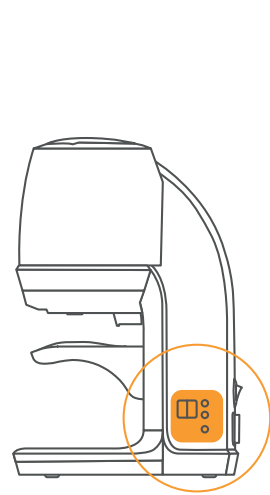

1. Press "Cleaning".

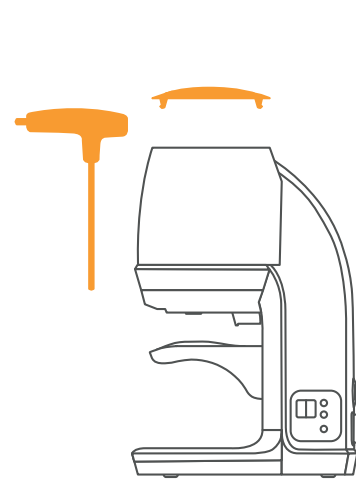

2. Remove top cover and get the Allen key.

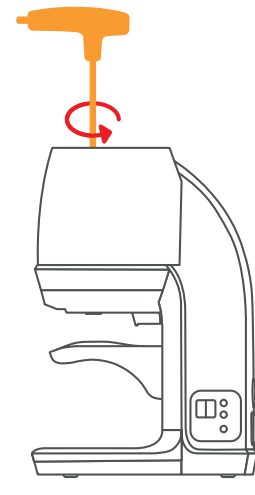

3. Unscrew by turning counter-clockwise.

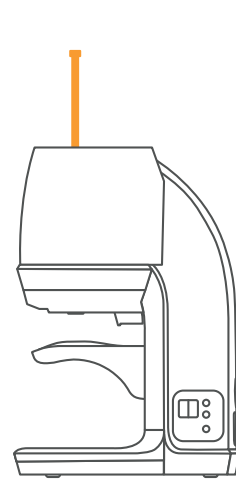

4. Remove bolt

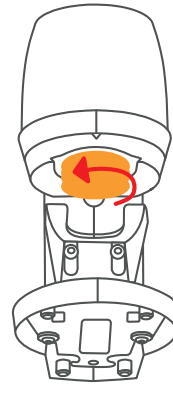

5. Remove tamper base by turning counter-clockwise.

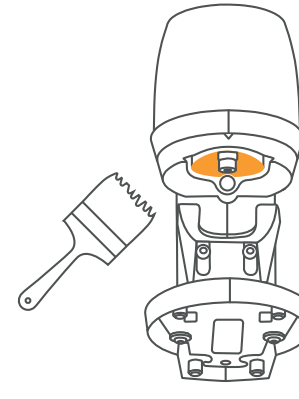

6. Clean cavity with a brush.

# Hey there!

Set up the Lower Clamp, **before you do anything else.**  
**Only then, every tamp will be perfectly level and safe.**

PUQ<sup>®</sup>  
PRESS

## Set up the Lower Clamp

PUQ PRESS®

## Cleaning

PUQ PRESS®

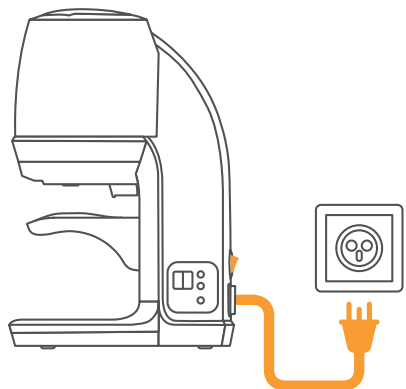

1. Insert power cable and turn on PUQpress. The tamper base will move to the upper position.

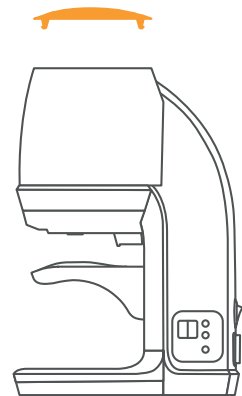

2. Remove the power cable.

3. Remove the top cover.

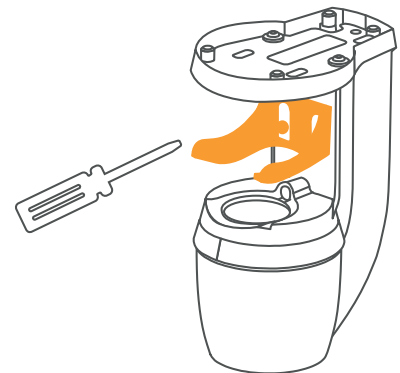

4. Turn Puq upside down on the table and unscrew the lower clamp.

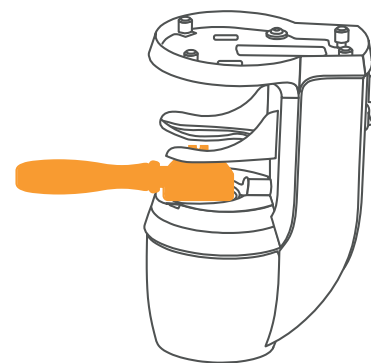

5. Push Portafilter (PF) in-between the upper- and lower clamp. Push lower clamp downward and tighten the screws.

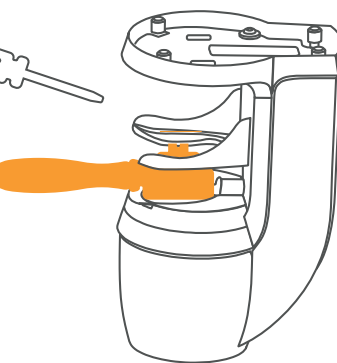

6. Check fitting and tighten screws firmly.

**WARNING:** Failure to adjust the lower clamp to optimum working position may allow contact with moving parts. Portafilter should not wiggle!  
For instruction video check [www.puqpress.com/support](http://www.puqpress.com/support)

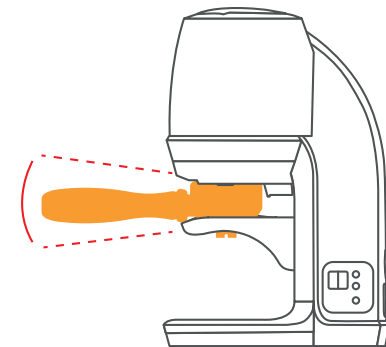

7. Put Puq back on its feet and test if the PF fits well.

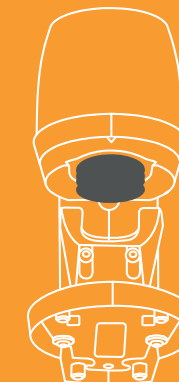

### Cleaning during your shift

Coffee can stick to your tamper while making coffees. Give it a quick wipe with a dry towel or cloth and you're good to go again!